

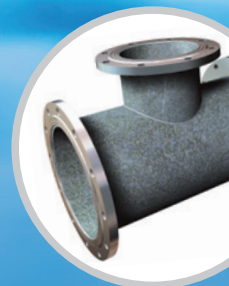

SVOBODNY SOKOL

DUCTILE IRON
PIPES AND FITTINGS
DN 80-1000 mm

THE WAY
TO PURE WATER

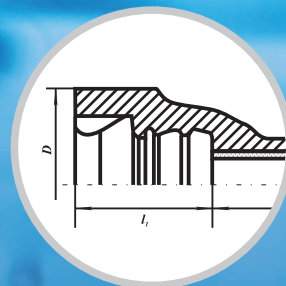
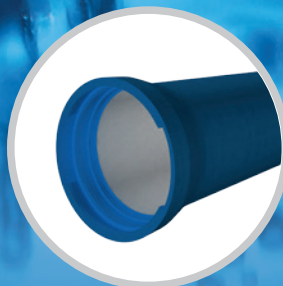
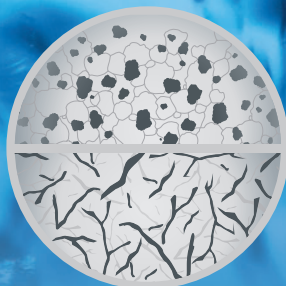

THE WAY TO PURE WATER

Conservation of pure water, assurance of drinking water quality, reduction of losses in everyday consumption becomes a vital problem for the mankind.

According to the United Nation data losses of potable water caused by supply system failures (pipelines, distribution devices) equal to its total consumption (!!!).

Developing countries having no modern and reliable pipeline systems suffer most from lack of proper quality potable water and its losses.

One more global problem is the transportation of household and industrial waste water with minimal losses, which means elimination of nature poisoning with human activity biowastes.

Ductile Iron Pipes are the most reliable, durable and cost-effective material for transportation of potable water, industrial and household waste water and for a great number of technological solutions.

Lipetsk Pipe Company Svobodny Sokol makes its contribution to nature conservation producing and supplying different kinds of pressure ductile iron pipes and fittings.

Capitals of about 100 countries are equipped with high-duty ductile iron pipelines. Over 1000 cities in various climatic zones of the world have chosen ductile iron pipelines.



ABOUT COMPANY

Lipetsk Pipe Company Svobodny Sokol is one of the oldest operations in central Russia successfully working in metallurgical production field for more than one hundred years.

Today it is a modern production consisting of seven shops and operating departments with well-developed infrastructure. Production of pressure ductile iron pipes and fittings is a core business of the factory.

The pipe-casting plant has modern equipment produced by the leading world companies.

Lipetsk Pipe Company Svobodny Sokol is proud to offer its partners extended range of pressure Ductile Iron Pipes (DIP) DN 80 – 1000 mm.

The 6 m. ductile iron pipes are manufactured with internal lining and external protective coatings. All pipe products are certified according to international and Russian standards and

have the expert assesment of the Federal Supervision Agency for Customer Protection and Human Welfare.

The main strategic aim of the plant is to become the leader on the local and international market, manufacturing high-quality and consumer oriented products, providing ecological and industrial safety of manufacture and a safe working environment.

For this purpose, we have the System of Management functioning at a production plant certified according to the requirements of International standards ISO 9001, ISO 14001 and OHSAS 18001. All products are certified and manufactured in strict compliance with standards ISO 2531, EN 545, EN 598, ISO 4179 and ISO 8179.

Lipetsk Pipe Company Svobodny Sokol is ready for mutually profitable and effective cooperation with local and foreign partners on the supply of high-quality pressure ductile iron pipes and fittings.



MECHANICAL PROPERTIES OF DUCTILE IRON

Ductile iron properties are the result of the adjunction of a small quantity of magnesium to the grey iron. After adjunction of magnesium to the iron, carbon crystallizes into graphite spheres enhancing the exceptional mechanical properties of the ductile spheroidal graphite iron close to the low carbon steel properties. In addition to excellent tensile strength, yield strength and elongation ductile iron has a high-level corrosion resistance.

Improved mechanical properties are explained by the chemical composition of iron and high temperature annealing which makes it possible to use the pipes under alternating load, earth motion and sagging.

Ductile iron pipes and pipelines can bear great diametral deflection during operation without losing functional properties that allows to withstand high thickness of soil and great traffic load.

Parameters	Ductile Iron
Tensile strength σ_b MPa (kgf/mm ²), not less	420 (42,8)
Conventional yield point $\sigma_{0,2}$ MPa (kgf/mm ²), not less	300 (30,6)
Breaking elongation %, not less	10

Metallographic Structure



Grey iron

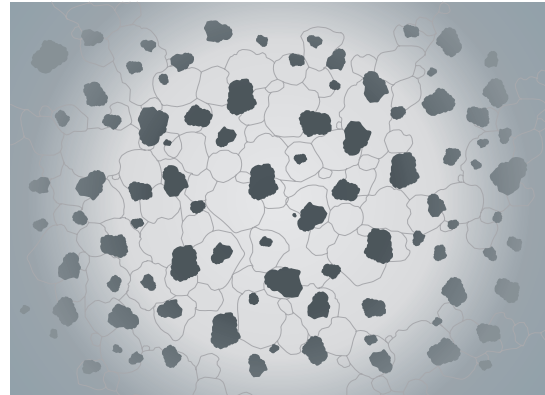

Ductile Iron

Demonstration of Ductile Iron Pipes Mechanical Properties





DUCTILE IRON PIPES ADVANTAGES

Ductile iron pipes have been used in the world for already sixty years. Today ductile iron pipes are the most promising regarding such parameters as «price + quality + ecological safety»

Ductile Iron Pipes Mean:

Durability

Total Corrosion , mm/year		
	Ductile Iron	Steel 20
Sea water	0,01-0,06	0,1-0,8
Steam and hot water pipelines	0,011	0,048
Petroleum containing liquids	0,013	0,053

■ The expected faultless service life of ductile iron pipeline systems:

- In water supply networks under condition of soil corrosion, stray current and absence of cathodic protection is 80 to 100 years.

- In sewage networks with hydrogen sulphure it reaches 50 to 60 years.

■ Corrosion resisting properties of ductile iron pipes are 5-10 times higher than steel pipes.

Easy Installation

■ Power costs, special equipment and highly qualified staff are not required.

■ Laying directly in the ground at a depth of 8-10 m. without bed preparation is possible.

■ Installation works at negative temperatures are allowed.



Energy Saving

■ Inside cement mortar lining of the ductile iron pipes does not only ensure observation of the hygienic requirements at potable water transportation, but also improves the hydraulic properties of the ductile iron pipelines.

Roughness factor (as per COLEBROOK formula) of the inner surface of the ductile iron pipe with inside cement-mortar lining is $K = 0,03$ for a single pipe. It is recommended to take $K = 0,1$ for DN 80-250 mm.; $K = 0,08$ for DN 300-700 mm.; $K = 0,05$ for DN 700-1000 mm. for calculations when designing pipeline systems out of ductile iron so that

all friction losses in the assembled pipeline system are considered. That means that ductile iron pipes with inside cement-mortar lining permit to reduce hydraulic losses through friction in the pipeline to a considerable extent and correspond to all the modern energy conservation requirements.

Besides, big flow section of ductile iron pipes compared to polyethylene pipes (with the equal value of nominal bore DN) makes possible a considerable pumping cost reduction of the transported liquid.

Reliability

■ Unique properties of ductile iron pipelines provide:

- no corrosion in conjunction with high mechanical properties and functional features of spigot and socket connections;
- high safety margin compared to other pipeline systems;
- cold resistance (impact strength of ductile iron pipes does not change in the range from plus 20°C to minus 60°C)

■ Ductile iron pipes have less failure compared to pipelines of other materials.

Numerous tests have proven that along with the estimated permissible load ductile iron pipes have sufficient reserve reliability. It is ideal for complicated laying conditions.

Environmentally Friendly

■ Ductile Iron Pipelines with inside cement-mortar lining guarantee high quality of transported water that meet all the requirements of hygienic safety (water PH up to 12,0)

■ Ductile iron pipeline systems are impermeable for hydrocarbons and chemical substances that can be found in envionring soils.

■ Complete recycling of the pipes after the service.

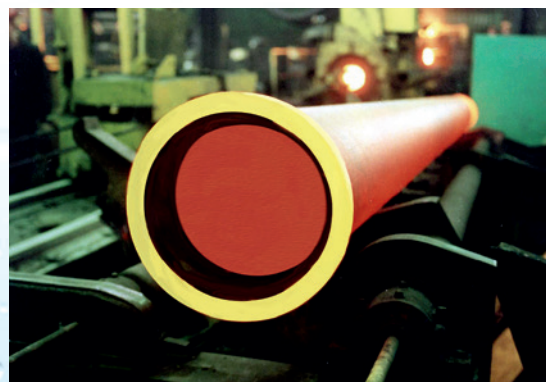



PIPE MANUFACTURING PROCESS

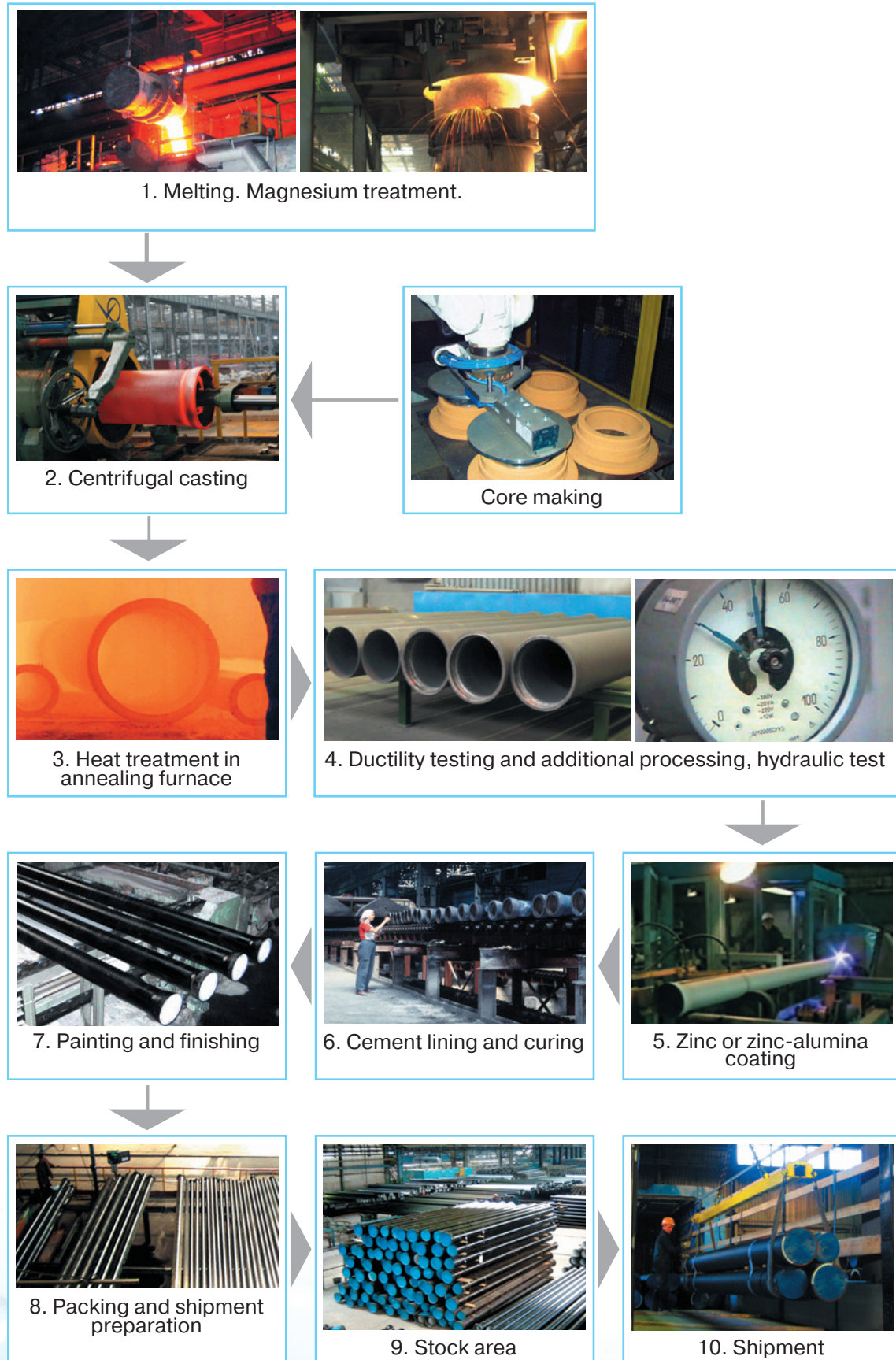

DUCTILE IRON PIPES

The 6 m. ductile iron pipes are manufactured with internal lining and external protective coatings by the Lipetsk Pipe Company Svobodny Sokol in accordance with ISO 2531, EN 545, EN 598.

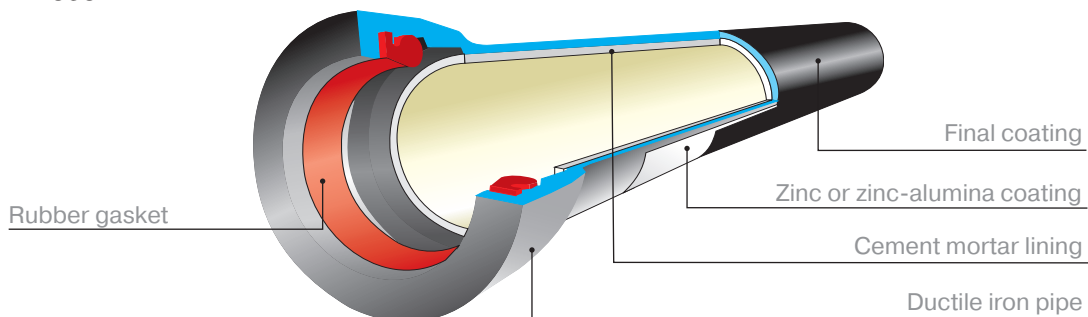

Outer Coating Of The Ductile Iron Pipes

Zinc and final coatings are applied to the outer pipe surface according to ISO 8179.

Ductile Iron Pipes Lining

The inner surface of the pipe may have cement mortar lining (CML). (Thickness and properties to ISO 4179).

The unique properties of the cement mortar lining lie in both passive and active protective effect.

In case of aggressive soil or transported liquid other types of coatings can be used. It is recommended to consult the manufacturer on their application.

Cement Mortar Lining Functioning

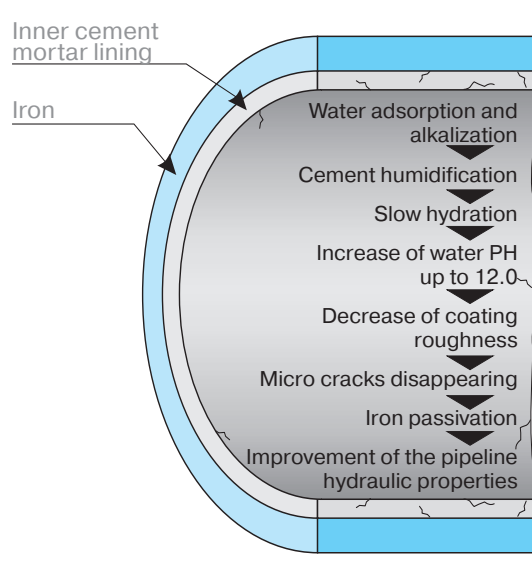

Ductile iron pipe range according to pressure classes

DN, mm	Allowable operational pressure, bar														
	Pressure class														
	C100	C64	C50	C40	C30	C25	C100	C64	C50	C40	C30	C40	C30	C25	
	«TYTON»						«RJ»					«RJS»			
80															
100															
125															
150	100	64					64	40		40					
200									40						
250			50	40											
300															
350										30					
400											30				
500												30			
600															
700					30										
800						25							25	16	
900															
1000															

Note: Allowable working pressure corresponds with class nominal. PFA=C. For example C100 - allowable working pressure is 100 bar. It works only for "Tyton" joint. For restrained socket joints RJ and RJS the allowable working pressure can't correspond with the class nominal because of the construction peculiarities, it is set by the Manufacturer.



APPLICATION FIELD

- **Water Supply**

Outdoor networks and structures.
Industrial water-desalinating plant.

- **Sewer System**

Outdoor networks and structures.

- **Snow Making**

High-quality pipelines for sky resort artificial snow making system.

- **Pipelines For Drainage And Irrigation**

- **Pipelines For Fire-Extinguisher Systems**

- **Electrochemical Protection Of The Underground Metal Constructions**

- **Ductile Iron Piles**

Reliable system for foundation laying of civil, industrial and purpose-built construction.

Ductile iron pipes application in other areas is specified by the Manufacturer.

Water Supply

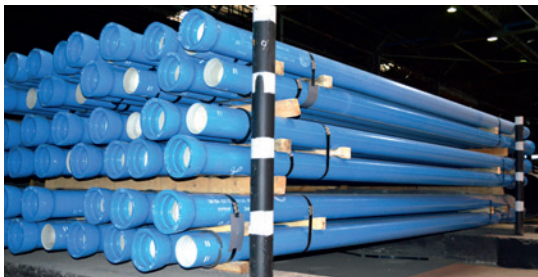

■ External water supply networks.

■ Industrial desalination units.

Ductile iron is the most reliable, long life performance, economic and environmentally friendly material for potable life delivery and a decision for a great range of technological aims.

Lipetsk Pipe Company Svobony Sokol produces different types of pressure pipes and fittings from ductile iron according to ISO 2531, EN 545, EN 598.

Internal anti-corrosive cement mortar lining according to ISO 4179 have passed quality tests and confirmed by WRAS certificate that confirms the usage of the lining in the contact with potable water and corresponds with the requirements of the standard BS6920.

Depending on the working condition, the **outer coating** can be used in different combinations:

- Metal zinc + finishing layer (bituminous paint based on synthetic resin or epoxy) according to ISO 8179-1
- Zinc-alumina + finishing layer (bituminous paint based on synthetic resin or epoxy) according ISO 8179-1
- Without any or all the coverings according to customer's desire

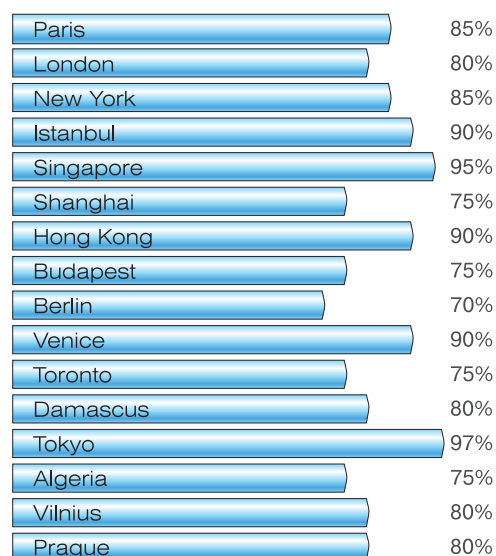

Rate of ductile iron pipeline systems in the water supply systems of the largest cities in the world

Sewer System



- Pressure sewage systems.
- Storm water systems.

Ductile iron pipelines allow to solve the task with the sewerage liquid transportation on big distances from the living apartments to effluent treatment plants providing high reliability leakproofness and durability of water disposal system.

For sewerage pipelines of different purposes Svobodny Sokol offers socket joint pipelines and fittings made of ductile iron and corresponding to Europe standards EN 598 DN 80-1000 mm.

The leakproofness of the socket-straight end connection is reached with the compression or the resin gasket. The materials used while gasket manufacture process passed all the necessary selection and tests in regarding with the possibility of saving all the physico-mathematical characteristics in case of contacting with aggressive soil condition.

For pipeline **internal protection** can be used the lining based on portland-cement, sulphate-resistant cement and high-alumina cement depending on aggressive liquid transportation influence.

The choice of the internal lining should be considered according to EN 545 and EN 598 standards.

Liquid transportation	Portland-cement	Sulphate-resistant cement	High-alumina cement
Minimal PH level	6	5,5	4
Maximum content (mg/l):			
- aggressive CO ₂	7	15	No limits
- sulphates (SO ₄ ⁻²)	400	3000	No limits
- magnesium (Mg ⁺⁺)	100	500	No limits
- ammonium (NH ₄ ⁺)	30	30	No limits

Outer coating of the ductile iron pipelines: Zinc metal or zinc-alumina coating together with finishing layer according to ISO 8179-1.



Snow making for ski resorts



The main condition of normal snow making process is a reliable pipeline system for water supply that is confirmed with all the requires of highland systems under big pressure.

For the artificial snow making system we offer socket pipes made of ductile iron pipes with the "RJ" type of connection (DN 80-500mm)

In order to protect the pipes inside they are covered with cement mortar lining according to ISO 4179 standard. Outside the pipes are covered with metal zinc and finishing layer according to the standard ISO 8179.

Our advantages:

- Strong material and flexible types of connection
- High pressure resisting
- Simple and fast assembling without welding (to 400 meters per day)
- Angular deflection (to 5 degrees)
- Certificated quality according to ISO, EN standards
- Lifelong service is more than 100 years
- Norms and specifications for design process and ductile iron pipeline RJ joint in snow making sphere.

Basic dimensions

Working pressure			
DN	PFA	Class	Allowable angular deflection, degrees
80	4,0 МПа	K9	5°
	6,4 МПа	K10	
100	4,0 МПа	K9	5°
	6,4 МПа	K10	
125	4,0 МПа	K9	5°
	6,4 МПа	K11	
150	4,0 МПа	K9	5°
	6,4 МПа	K12	
200	4,0 МПа	K9	4°
	6,4 МПа	K14	
250	4,0 МПа	K10	4°
300	4,0 МПа	K10	4°
400	4,0 МПа	K11	3°
500	4,0 МПа	K12	3°

Ductile Iron Piles

Ductile iron piles are known as reliable system for setting up different foundations of civil, industrial and single purpose construction units.

A great range of projects with ductile iron piles in Austria, Germany, Portugal, Spain and all over Europe are a significant argument of the perfection for such a technical decision. Those places where the soil is unstable due to its geological peculiarities – ductile iron piles application is the best and the most reliable decision.

Ductile iron pile construction is one of the easiest, fastest, and available methods. For pile driving there is no need in heavy and special vehicles, a light excavator is enough. Instead of the ditching scoop, the hydraulic hammer with the pile adaptor is used. Before the first pile driving the pile straight end shoe is used for soft soils or rock pont for solid beds. The second pile is assembled in the socket of the first one. During the driving process a rigid and stable connection appears. The pile is driven in such a deep that can be assigned by the soil penetration resistance. Driven piles are filled with the concrete grout for load bearing capacity increase and for better soil corrosion resistance.

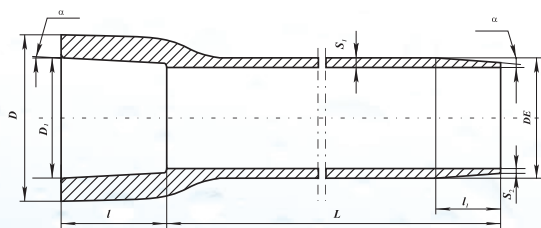
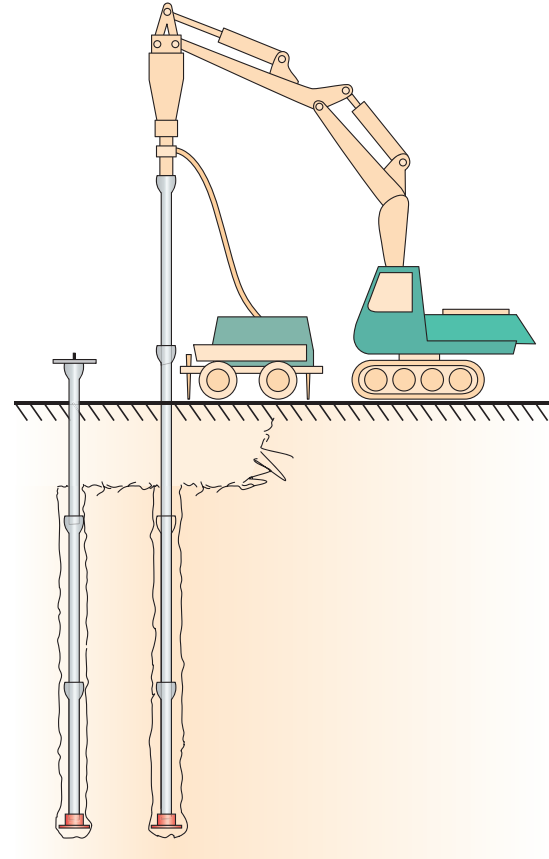

The piles are produced by the center die casting method and can be of two outer diameters 118 and 170 mm having different wall thickness depending on the requirements for carried load capacity. The pile has a socket with the conical internal surface and a straight-end with the conical outside surface. The effective length of the pile without a socket is 5500 mm.

Dimensions, mm							Estimated weight (kg) of the pipe with the length L, mm.	
DE	D	D ₁	L	L ₁	α°	S ₁	S ₂	5500
118 ^{+1,5} _{-1,0}	164 ⁺² ₋₁	118,5 ^{+0,5} _{-0,5}	155 ⁺¹ ₋₁	110 ₋₂₀	1,64	7,5 _{-0,8}	4,4 _{-0,8}	114,8
						9,0 _{-0,8}	4,4 _{-0,8}	133,6
						10,6 _{-0,8}	4,4 _{-0,8}	153,0
170 ^{+2,5} _{-1,5}	222 ⁺² ₋₁	171,5 ^{+0,5} _{-0,5}	215 ⁺¹ ₋₁	150 ₋₂₀	1,60	9,0 _{-0,8}	4,9 _{-0,8}	206,0
						10,6 _{-0,8}	4,9 _{-0,8}	235,7



Applications

■ Structural Engineering

Ductile iron piles are used for construction and reconstruction of the buildings with different purpose.

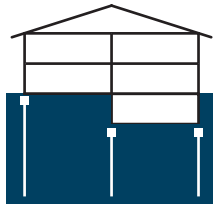

■ Pipeline support

Ductile iron piles are used for construction and reconstruction of main pipelines to support in unstable soil condition.



■ Pylons and wind turbines

Ductile iron piles serve to support antenna mast structures, open distribution systems, communication lines, as a foundation for overweight structures and for old-aged foundations stabilization.

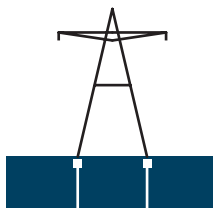

■ Stabilization of slopes.

Bridge and pier construction

The piles function for slopes, scars and splays stabilization. DIP can be a means of sagged earth and made ground strengthening, a way to support foundation during highways, bridges and railways construction.

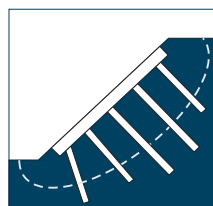

RANGE OF JOINTS

Socket «Tyton» Joint

Socket «Tyton» joint, with rubber gasket for use with the operating pressure from 2.5 to 10.0 MPa (depending on the diameter) for pipelines DN 80-1000 mm.

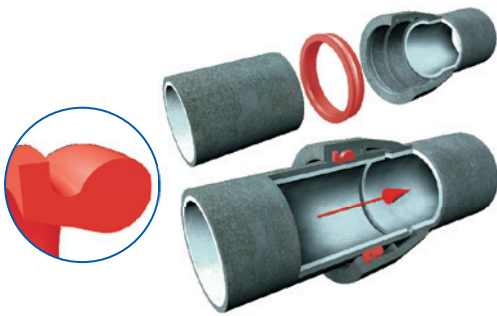

«RJ» Joint

Restrained socket joint with rubber gasket for use with the operating pressure from 3.0 to 6.4 MPa (depending on the diameter) for pipelines DN 80-500 mm.

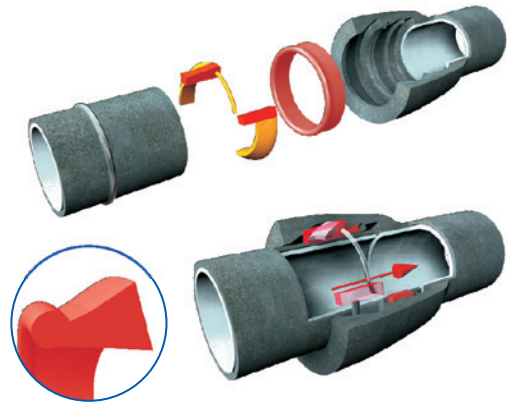

«RJS» Joint

Restrained socket joint with rubber gasket for use with the operating pressure from 1.6 to 2.5 Mpa (depending on the diameter) for pipelines DN 600-1000 mm.

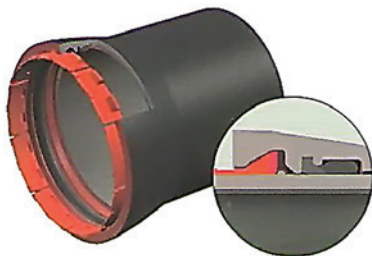

Pile Joint

Ductile iron cast piles outside diameters 118 and 170 mm with concrete or other filling for piles foundation. Designed as anode earthing for pipeline cathode protection and also for foundations, support structures and loose soils reinforcing.





FUNCTIONAL FEATURES OF SOCKET AND SPIGOT JOINTS

Socket joints are made in such a way that perfect tightness is ensured due to the contact pressure between the rubber gasket and the pipe material as well as due to the water pressure.

Socket type connection is not rigid and permits the connected pipes to move to the corner from 1.5 to 5° without joints losing tightness, it offers certain advantages when laying pipes and adjusting to the soil movement, besides it permits to lay pipes in a circle of big radius without fittings, and make adjustment to the pipeline route.

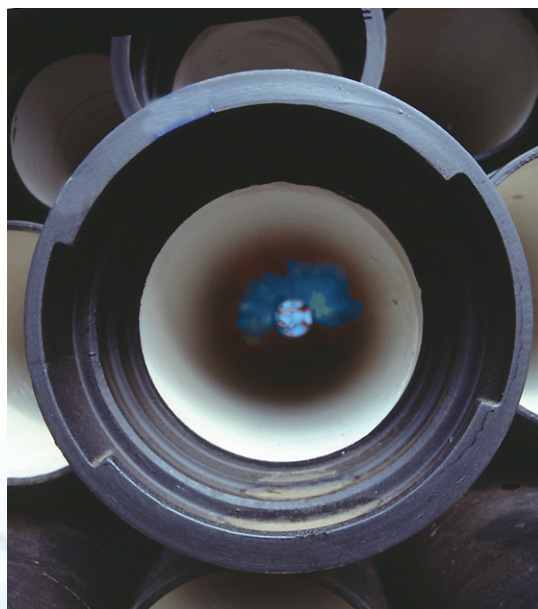
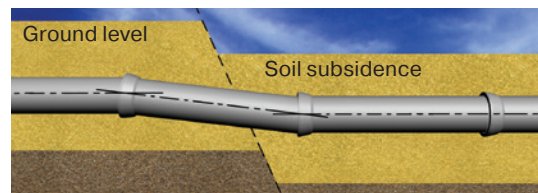
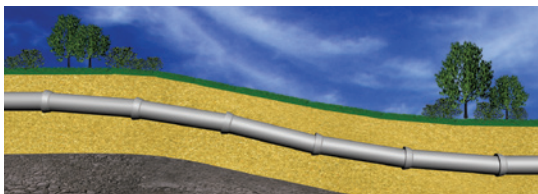
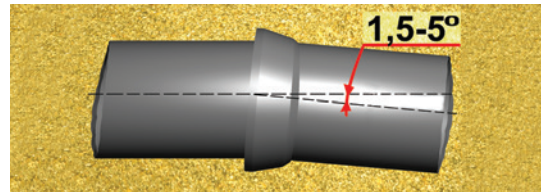
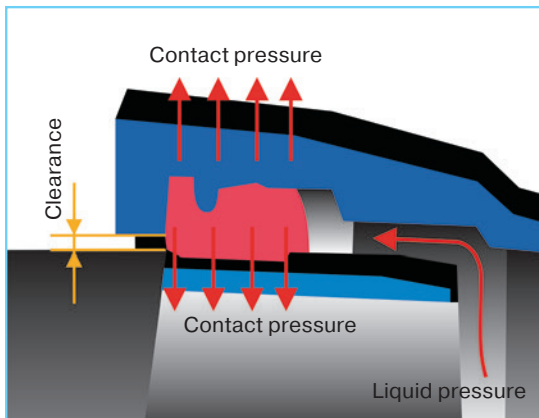

TYPE OF JOINTS

«TYTON» Joint

Socket-Joint Pipes for «Tyton» joint are furnished with rubber gaskets. Material composition and properties of the rubber gaskets are specified by the normative documentation.

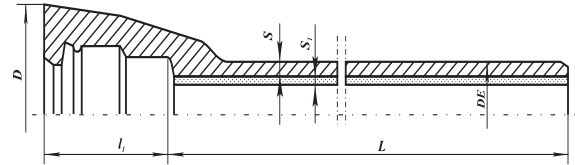

Basic dimensions, weight, allowable operating pressure, angular deflection for preferred pressure classes

Dimensions, mm						Allowable angular deflection, °	Pressure class	Pipe weight with socket and cement-mortar lining L, mm,	
DN	D	DE	S	S ₁	l ₁			5800	6000
80	140	98 ^{+1,0} _{-2,7}	4,4 ^{-1,4}	4 ^{+2,0} _{-1,5}	85	5	C40	71,7	74,1
100	163	118 ^{+1,0} _{-2,8}	4,4 ^{-1,4}	4 ^{+2,0} _{-1,5}	88	5	C40	87,4	90,3
125	190	144 ^{+1,0} _{-2,9}	4,4 ^{-1,4}	4 ^{+2,0} _{-1,5}	91	5	C40	108,4	111,9
150	217	170 ^{+1,0} _{-2,9}	4,5 ^{-1,5}	4 ^{+2,0} _{-1,5}	94	5	C40	131,1	135,4
200	278	222 ^{+1,0} _{-3,0}	4,6 ^{-1,5}	4 ^{+2,0} _{-1,5}	100	4	C40	176,5	182,2
250	336	274 ^{+1,0} _{-3,3}	5,5 ^{-1,6}	4 ^{+3,0} _{-1,5}	105	4	C40	251,5	259,5
300	393	326 ^{+1,0} _{-3,4}	6,2 ^{-1,6}	4 ^{+3,0} _{-1,5}	110	4	C40	330,9	341,7
350	448	378 ^{+1,0} _{-3,4}	6,4 ^{-1,7}	5 ^{+3,5} _{-2,0}	110	3	C30	411,2	424,6
400	500	429 ^{+1,0} _{-3,5}	6,5 ^{-1,7}	5 ^{+3,5} _{-2,0}	110	3	C30	475,9	491,3
500	604	532 ^{+1,0} _{-3,8}	7,4 ^{-1,9}	5 ^{+3,5} _{-2,0}	120	3	C30	659,4	680,7
600	713	635 ^{+1,0} _{-4,0}	8,6 ^{-1,9}	5 ^{+3,5} _{-2,0}	120	3	C30	894,4	923,2
700	824	738 ^{+1,0} _{-4,2}	8,8 ^{-2,0}	6 ^{+4,0} _{-2,5}	150	2	C25	1100,6	1135,8
800	943	842 ^{+1,0} _{-4,5}	9,6 ^{-2,1}	6 ^{+4,0} _{-2,5}	160	2	C25	1356,4	1399,6
900	1052	945 ^{+1,0} _{-4,8}	10,6 ^{-2,2}	6 ^{+4,0} _{-2,5}	175	1,5	C25	1659,1	1711,9
1000	1158	1048 ^{+1,0} _{-5,0}	11,6 ^{-2,3}	6 ^{+4,0} _{-2,5}	185	1,5	C25	1994,7	2057,9

Rubber Gasket «Tyton»

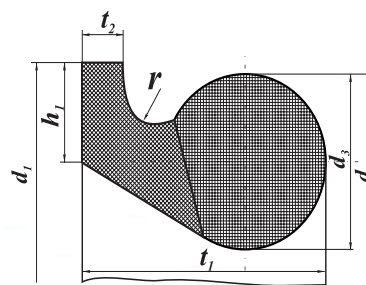

Basic dimensions and weight

Dimensions, mm								Weight, kg (for reference)
DN	d ₁	d ₂	d ₃	h ₁	t ₁	t ₂	r	
80	126 ^{+1,0}	124 ^{+1,0}	16 ^{+0,5}	10 ^{+0,3}	26	5 ^{+0,4} _{-0,2}	3,5	0,13
100	146 ^{+1,0}	144 ^{+1,0}	16 ^{+0,5}	10 ^{+0,3}	26	5 ^{+0,4} _{-0,2}	3,5	0,21
125	173 ^{+1,0}	171 ^{+1,0}						0,29
150	200 ^{+1,5}	198 ^{+1,5}	18 ^{+0,5}	11 ^{+0,3}	30	6 ^{+0,4} _{-0,2}	4,0	0,36
200	256 ^{+1,5}	254 ^{+1,5}			32			0,50
250	310 ^{+1,5}	308 ^{+1,5}			34			0,72
300	366 ^{+1,5}	364 ^{+1,5}	20 ^{+0,5}	12 ^{+0,3}	34	7 ^{+0,4} _{-0,2}	4,5	0,94
350	420 ^{+2,0}	418 ^{+2,0}						1,25



Dimensions, mm								Weight, kg (for reference)
DN	d_1	d_2	d_3	h_1	t_1	t_2	r	
400	$475^{±2,0}$	$473^{±2,0}$	$22^{+0,5}$	$13^{+0,3}$	38	$8^{+0,5}_{-0,3}$	5,0	1,54
500	$583^{±3,0}$	$581^{±3,0}$	$24^{+0,5}$	$14^{+0,3}$	42	$9^{+0,5}_{-0,3}$	5,5	2,45
600	$692^{±3,0}$	$690^{±3,0}$	$26^{+0,5}$	$15^{+0,3}$	46	$10^{+0,5}_{-0,3}$	6,0	3,34
700	$809^{+5,0}_{-2,5}$	$803^{±3,5}$	$33,5^{+0,5}$	$20^{+0,3}$	55	$16^{+0,5}_{-0,3}$	7,0	4,55
800	$919^{+5,0}_{-2,5}$	$913^{±3,5}$	$35,5^{+0,5}$	$21^{+0,3}$	60		8,0	5,51
900	$1026^{+6,0}_{-2,0}$	$1020^{±4,0}$	$37,5^{+0,5}$	$22^{+0,3}$	65	$18^{+0,5}_{-0,3}$	9,0	6,30
1000	$1133^{+7,0}_{-2,0}$	$1127^{±4,0}$	$39,5^{+0,5}$	$23^{+0,3}$	70			7,04

«TYTON-SIT» Joint

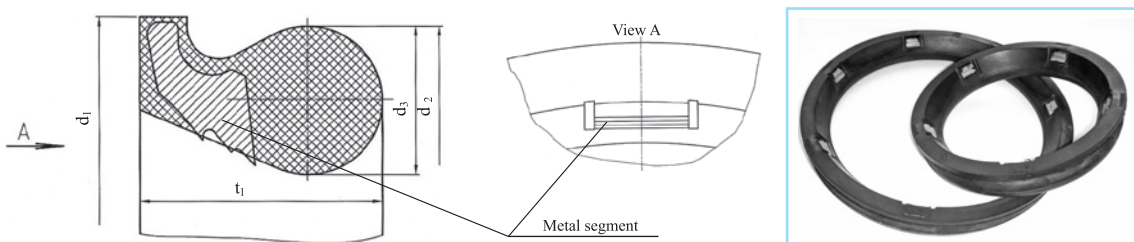

This connection type is equipped with the ductile iron pipe TYTON type and a self-restrained gasket of Tyton-Sit type with metal segments.

The joint can be used in unstable soil environment; it does not require concrete thrust blocks for axial hydraulic pressure compensation when laid in the places with the pipeline direction (with tees, turns and increasers) or diameter change.

Basic dimensions and parameters

Dimensions, mm					Pressure classes	Allowable working pressure (PFA), bar	Number of locking segments	Angular deflection
DN	d_1	d_2	d_3	t_1				
80	$126^{±1,0}$	$124^{±1,0}$	$16^{+0,5}$	26	C100	16	4	3
100	$146^{±1,0}$	$144^{±1,0}$	$16^{+0,5}$	26	C100	16	5	3
125	$173^{±1,0}$	$171^{±1,0}$	$16^{+0,5}$	26	C64	16	5	3
150	$200^{±1,5}$	$198^{±1,5}$	$16^{+0,5}$	26	C64	16	7	3
200	$256^{±1,5}$	$254^{±1,5}$	$18^{+0,5}$	30	C64	16	10	3
250	$310^{±1,5}$	$308^{±1,5}$	$20^{+0,5}$	32	C50	10	15	3
300	$366^{±1,5}$	$364^{±1,5}$	$21^{+0,5}$	34	C50	10	20	3
400	$475^{±2,0}$	$473^{±2,0}$	$23^{+0,5}$	38	C50	10	30	3

«RJ» Joint

Due to the «RJ» joint the pipe does not get disconnected when laid in a rough terrain, at the places with the danger of sagging or in case of impact load. Circular bead at the pipe spigot and two stoppers inserted into the recess of the socket after connection and fixed with a retaining wire stop the pipes from disconnecting. It is especially important when pipelines are laid in unstable soil, mountainous areas and in vertical position. The «RJ» joint is recommended for pipelines laying by the trenchless methods. Areas of

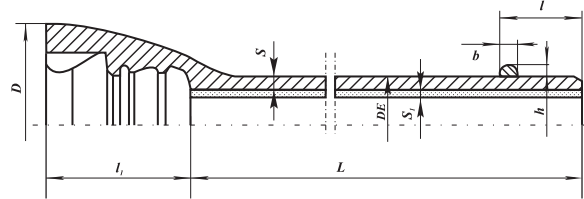

application are - cold water supply, heating system, sewage system. Spigot and socket pipes with «RJ» joint are equipped with rubber gaskets RJ (p.18) or TYTON type (p. 16) and anchors.

Basic dimensions, weight, allowable operating pressure, angular deflection

Dimensions, mm									Allowable angular deflection, °	Pressure class/PFA, bar	Pipe weight with socket and cement-mortar lining L, mm,	
DN	D	DE	S	S ₁	l	l ₁	h	b			5800	6000
80	156	98 ^{+1,0} _{-2,7}	6,1 ^{-1,4}	4 ^{+2,0} _{-1,5}	85	127	5,0	8 ^{±2}	5	C100/64	92,7	95,7
			5,4 ^{-1,4}							C64/40	85,0	87,7
			4,9 ^{-1,4}							C50/40	79,4	81,9
			4,4 ^{-1,4}							C40/40	73,7	76,1
100	176	118 ^{+1,0} _{-2,8}	6,1 ^{-1,4}	4 ^{+2,0} _{-1,5}	91	135	5,0	8 ^{±2}	5	C100/64	113,5	117,2
			5,4 ^{-1,4}							C64/40	104,0	107,3
			4,9 ^{-1,4}							C50/40	97,1	100,2
			4,4 ^{-1,4}							C40/40	90,0	92,9
125	205	144 ^{+1,0} _{-2,9}	6,4 ^{-1,4}	4 ^{+2,0} _{-1,5}	95	143	5,0	8 ^{±2}	5	C100/64	145,7	150,4
			5,4 ^{-1,4}							C64/40	128,7	132,8
			4,9 ^{-1,4}							C50/40	120,1	123,9
			4,4 ^{-1,4}							C40/40	111,5	115,0
150	230	170 ^{+1,0} _{-2,9}	7,4 ^{-1,5}	4 ^{+2,0} _{-1,5}	101	150	5,0	8 ^{±2}	5	C100/64	193,9	200,2
			5,5 ^{-1,5}							C64/40	155,4	160,4
			5,0 ^{-1,5}							C50/40	145,2	149,8
			4,5 ^{-1,5}							C40/40	134,7	139,0
200	288	222 ^{+1,0} _{-3,0}	9,2 ^{-1,5}	4 ^{+2,0} _{-1,5}	106	160	5,5	9 ^{±2}	4	C100/64	307,1	317,1
			6,5 ^{-1,5}							C64/40	235,0	242,5
			5,4 ^{-1,5}							C50/40	204,9	211,4
			4,6 ^{-1,5}							C40/40	183,0	188,7
250	346	274 ^{+1,0} _{-3,1}	11,1 ^{-1,6}	4 ^{+3,0} _{-1,5}	106	165	5,5	9 ^{±2}	4	C100/64	447,6	462,2
			7,7 ^{-1,6}							C64/40	335,0	345,7
			6,4 ^{-1,6}							C50/40	291,0	300,2
			5,5 ^{-1,6}							C40/40	260,3	268,5
300	402	326 ^{+1,0} _{-3,3}	6,2 ^{-1,6}	4 ^{+3,0} _{-1,5}	106	170	5,5	9 ^{±2}	4	C40/30	341,6	352,4
			7,3 ^{-1,6}							C50/40	386,3	398,6
350	452	378 ^{+1,0} _{-3,4}	6,4 ^{-1,7}	5 ^{+3,5} _{-2,0}	110	180	6,0	10 ^{±2}	3	C30/30	423,3	436,6
			7,0 ^{-1,7}							C40/30	451,7	466,0
			8,3 ^{-1,7}							C50/40	512,9	529,4
400	513	429 ^{+1,0} _{-3,5}	6,5 ^{-1,7}	5 ^{+3,5} _{-2,0}	115	190	6,0	10 ^{±2}	3	C30/30	490,9	506,3
			7,7 ^{-1,7}							C40/30	555,8	573,4
			9,2 ^{-1,7}							C50/40	636,2	656,6
500	618	532 ^{+1,0} _{-3,8}	7,4 ^{-1,8}	5 ^{+3,5} _{-2,0}	120	200	6,0	10 ^{±2}	3	C30/30	679,4	700,7
			9,3 ^{-1,8}							C40/30	807,0	832,7
			11,1 ^{-1,8}							C50/40	927,1	956,9



Rubber Gaskets «RJ»

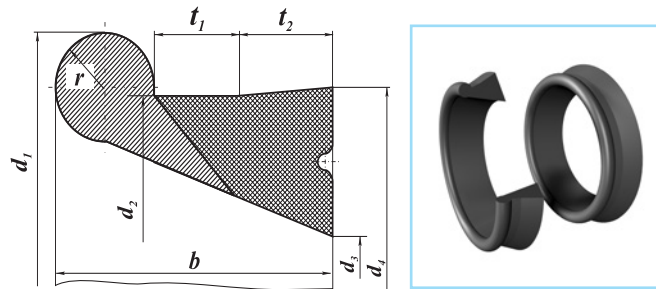

Basic dimensions and weight

Dimensions, mm									weight, kg (for reference)
DN	d ₁	d ₂	d ₃	d ₄	b	t ₁	t ₂	r	
100	146,5 ^{±1,0}	134,5 ^{±1,0}	99,5 ^{±1,0}	140,5 ^{±1,0}	30	5,5	14,3	5,0	0,17
150	203,5 ^{±1,5}	189,5 ^{±1,5}	151,0 ^{±1,5}	196,0 ^{±1,5}	32	5,5	15,3	5,5	0,41
200	260,0 ^{±1,5}	244,0 ^{±1,5}	202,0 ^{±1,5}	250,0 ^{±1,5}	33	5,5	15,3	6,0	0,50
250	315,0 ^{±1,5}	299,0 ^{±1,5}	257,0 ^{±1,5}	305,0 ^{±1,5}	33	5,5	15,3	6,0	0,63
300	369,0 ^{±1,5}	353,0 ^{±1,5}	311,0 ^{±1,5}	359,0 ^{±1,5}	33	5,5	15,3	6,0	0,95

Anchors For «RJ» Joint

Basic dimensions and weight

DN, mm	b ₁ , mm	b ₂ , mm	b ₃ , mm	h, mm	R, mm	α°	β°	c°	c, mm	Weight of stoppers	
										left with the retaining wire, kg	right, kg
80	48	38	24	17	49	78	12	92	90	0,23	0,20
100	50	38	24	17	59	78	11	93	107	0,26	0,22
125	52	40	25	18	72	78	10	94	128	0,37	0,32
150	55	43	26	18	85	78	9	95	152	0,43	0,38
200	60	48	26	19	111	78	8	96	197	0,60	0,54
250	65	53	28	21	137	80	7	97	243	0,85	0,77
300	70	58	30	22	163	50	6	56	167	0,77	0,70
350	75	63	34	23	189	50	5,5	54,5	188	0,99	0,92
400	80	67	38	24	214	50	5	53	207	1,18	1,10
500	85	72	38	24	266	48	4,5	51,5	248	1,46	1,38

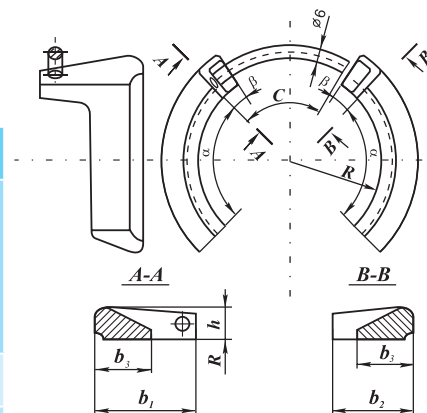

* Instead of a lock wire a rubber lock pin can be used

Clamping Ring For «RJ» Joint

Clamping ring is applied to fix the joint when the pipe is cut.

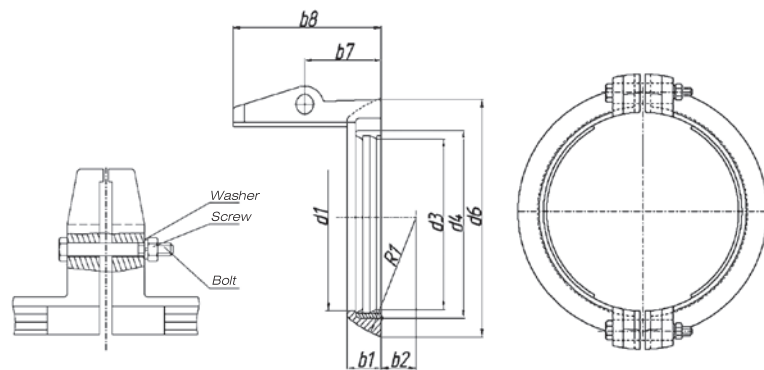

Basic dimensions and weight

DN, mm	Dimensions, mm									Weight, kr	PFA, bar	Bolt ISO 4014	Screw ISO 4032	Washer GOST 16402
	d ₁	d ₂	d ₃	d ₆	b ₁	b ₂	b ₇	b ₈	R ₁					
80	99,0	97,0	108,0	130,5	24	23	57	105	70	1,3	50	M12x80	M12	12 65 U
100	119,0	117,0	128,0	150,4	24	25	57	105	80	1,5	50			
150	171,0	169,0	180,0	204,0	26	32	61	115	108	2,2	50			
200	223,0	221,0	232,0	257,7	26	40	70	125	136	2,7	50			
250	275,0	273,0	286,0	314,3	28	50	78	125	166	3,8	50			
300	327,0	325,0	338,0	367,2	30	55	78	125	193	4,6	35			
400	430,0	428,0	443,0	475,3	38	65	89	140	248	6,1	30			
500	533,0	531,0	546,0	577,8	38	75	89	140	300	7,8	30			

«RJS» Joint

The push-on restrained joint «RJS» with rubber gasket for DN 600mm - DN 1000mm is recommended for pipelines laying in unstable soils, mountainous, earthquake prone areas and swampy grounds. The pipes with this type of joint can be successfully used for trenchless pipelaying. The «RJS» system provides joint efficiency due to the bead on the spigot end of pipe and stoppers sliding into the socket opening when the joint assembled.

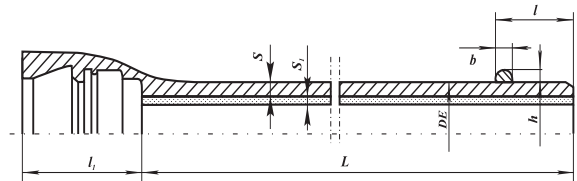

The restrained push-on joint pipes are supplied complete with «TYTON» rubber gaskets (p. 16) and anchors which should be fixed with metal strip for moving of assembled pipeline string.

Basic dimensions, weight, allowable operating pressure, angular deflection

DN	D	DE	Dimensions, mm						Allowable angular deflection, °	Pressure class/PFA, bar	Pipe weight with socket and cement-mortar lining L, mm,	
			S	S ₁	l	l ₁	h	b			5800	6000
600	729	635 ^{+1,0} _{-4,0}	7,5 ^{-1,9}	5 ^{+3,5} _{-2,0}	120	200	7,0	11 ^{±2}	3	C25/16	863,6	890,2
			8,6 ^{-1,9}							C30/16	927,6	956,4
			10,8 ^{-1,9}							C40/25	1104,4	1139,3
700	848	738 ^{+1,0} _{-4,2}	8,8 ^{-2,0}	6 ^{+4,0} _{-2,5}	150	230	7,0	11 ^{±2}	2	C25/16	1141,5	1176,7
			9,8 ^{-2,0}							C30/16	1235,3	1273,8
			12,4 ^{-2,0}							C40/25	1478,3	1525,1
800	960	842 ^{+1,0} _{-4,5}	9,6 ^{-2,1}	6 ^{+4,0} _{-2,5}	160	245	7,0	11 ^{±2}	2	C25/16	1407,8	1451,0
			11,0 ^{-2,1}							C30/16	1557,9	1606,3
			14,0 ^{-2,1}							C40/25	1878,0	1937,4
900	1060	945 ^{+1,0} _{-4,8}	10,6 ^{-2,2}	6 ^{+4,0} _{-2,5}	175	260	7,5	11 ^{±2,5}	1,5	C25/16	1723,1	1775,9
			12,2 ^{-2,2}							C30/16	1916,0	1975,4
			15,5 ^{-2,2}							C40/25	2311,5	2384,5
1000	1164	1048 ^{+1,0} _{-5,0}	11,6 ^{-2,3}	6 ^{+4,0} _{-2,5}	185	270	7,5	11 ^{±2,5}	1,5	C25/16	2072,4	2135,6
			13,4 ^{-2,3}							C30/16	2313,1	2384,6
			17,1 ^{-2,3}							C40/25	2805,2	2893,7



Anchors For «RJS» Joint

Basic dimensions and weight

DN, mm	R, mm	Quantity of stoppers, pcs.	Weight of stoppers, kg	
			Weight of one stopper	Weight of set for one joint
600	317,5	10	1,8	18
700	369,0	10	2,0	20
800	421,0	10	2,1	21
900	472,5	13	2,2	28,6
1000	524,0	14	2,6	36,4

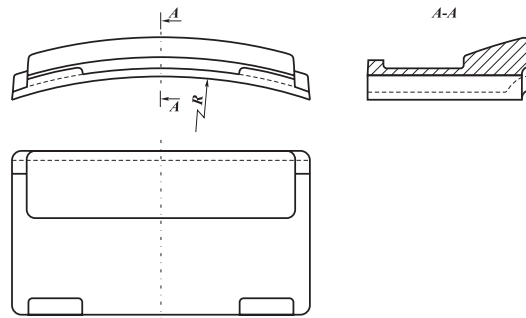

Polyethylene Sleeve

Polyethylene sleeve is applied additionally to standard external coating as well as in cases of corrosive soils and ground currents.

Basic dimensions

Nominal bore of the pipe, mm	L, mm	l*, mm	Nominal bore of the pipe, mm	L, mm	l*, mm	Nominal bore of the pipe, mm	L, mm	l*, mm
80	6600	300	250	6600	600	600	6600	1300
100	6600	300	300	6600	800	700	6600	1600
125	6600	400	350	6600	850	800	6600	1800
150	6600	400	400	6600	950	900	6600	2200
200	6600	600	500	6600	1150	1000	6600	2200

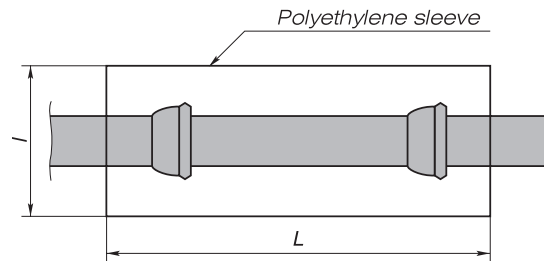

* – Width of the sleeve in a flat (folded twice) condition.

CAST FITTINGS

Characteristics Of Fittings

The fittings are manufactured of ductile iron by casting method and comply with the ISO 2531 requirements.

Inner Lining

Cement mortar lining is applied to the inner surface of the fittings according to the ISO 4179 requirements.

Outer Coating

The protective coating of bituminous paint is applied on outside surface of fittings.

Marking

The fittings shall bear paint or cast marks at the outside surface indicating:

- manufacturer's mark;
- ductile iron symbol;
- nominal diameter;
- year of manufacture.



Main characteristics of the fittings are listed in the table below:

Parameter	Value
Tensile strength σ_B , not less MPa (kgf/mm ²)	420 (42,0)
Conventional yield point $\sigma_{0,2}$, not under MPa (kgf/mm ²)	300 (30,0)
Breaking elongation, not less, %	5,0
Hardness	Max 250 HB
Pressure test, MPa	1,0 – 2,5

ASSEMBLING PIPES AND FITTINGS

Assembling Of The Push-On System Joint «Tyton»



1. Spigot cleaning



2. Insertion special mark on the straight pipe end



3. Greasing of the outside surface of the straight pipe end

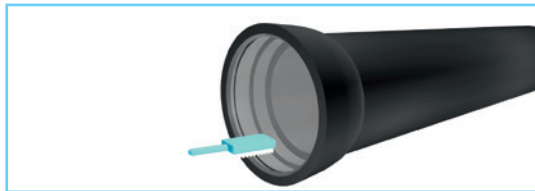

4. Socket cleaning



5. Inserting the rubber gasket into the socket



6. Greasing the inner surface of the rubber gasket



7. Assembled push-on joint

Assembling Of The «RJ» Joint



1. Spigot cleaning and greasing

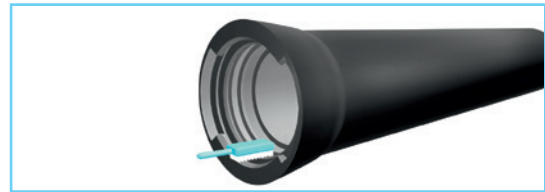

2. Socket cleaning



3. Inserting the rubber gasket into the socket



4. Greasing the inner surface of the socket

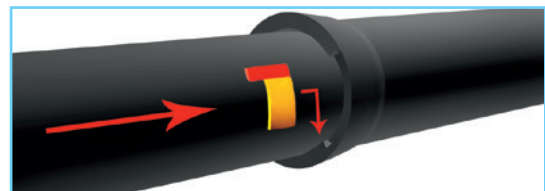

5. Connecting the pipes and inserting the right stopper

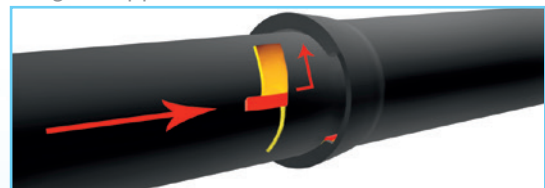

6. Inserting the left stopper. Fixation by the retaining wire

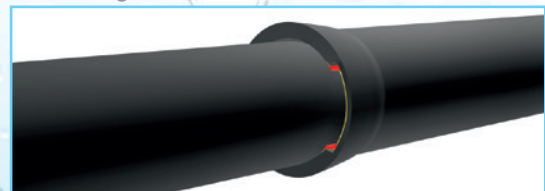

7. Assembled push-on joint



Assembling Of The «RJS» Joint



1. Spigot cleaning

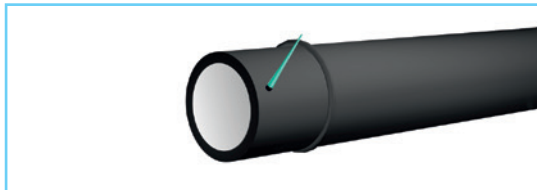

2. Greasing of the outside surface of the straight pipe end

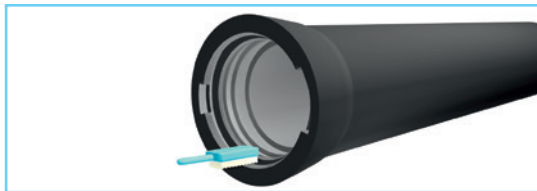

3. Socket cleaning

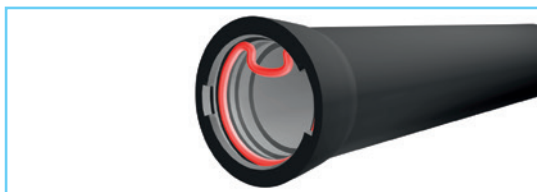

4. Inserting the rubber gasket into the socket

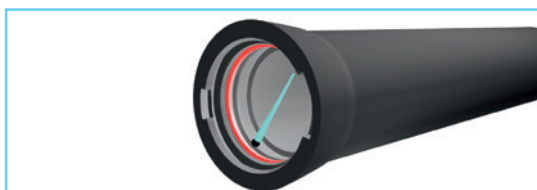

5. Greasing the inner surface of the rubber gasket



6. Connecting the pipes and inserting stoppers

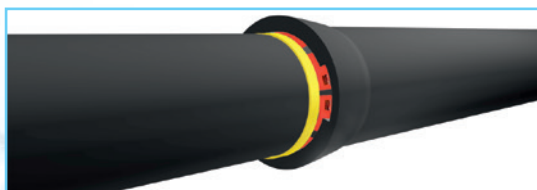

7. Fixation stoppers by the metal tape

Mounting Devices For Pipe And Fitting Assembly

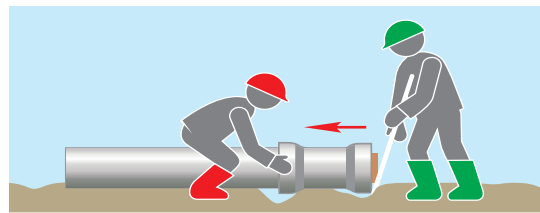
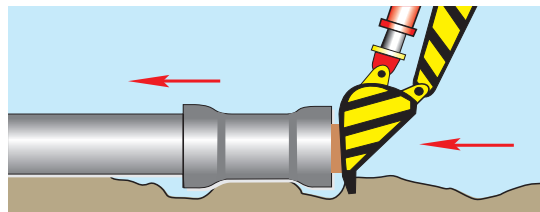
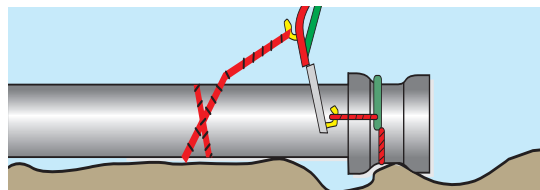
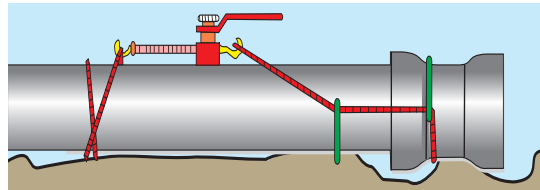

Filling Of The Pipeline Trenches

The pipeline covering should be done in two steps – partial covering before the preliminary test and the final covering after the preliminary hydraulic test.

First the filling of pockets and partial covering of the pipes to the height of not less than 0.5 m. is done in layers of 0.15-0.20 m., at the same time levering of the curved pipeline sections is carried out. Joints and sinks must remain open.

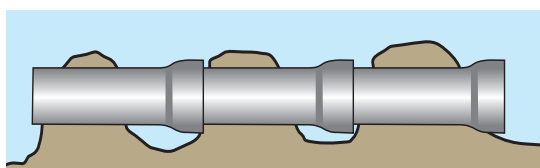

Partial covering of the pipeline for hydro testing

The final filling of the trench is done after the preliminary test of the pipeline. Pockets are filled and the joints are covered first, with thorough earth compaction.

SPECIFIC APPLICATION:

Horizontal Directional Drilling

Horizontal directional drilling is a technology of pipe laying that does not demand trench opening or carrying out works on the ground surface and provide the alternative pipe laying.

It is used when traditional (trench) pipe laying is impossible or limited by the necessity to cross natural (rivers, gullies, lakes, forests, specific grounds, etc.) or artificial (exclusion zones of power lines, main gas-, oil pipelines, compact planning, railroads, highways, etc.) obstacles.

Mechanical properties of ductile iron pipelines produced by SVOBODNY SOKOL allow using them for trenchless pipe laying. Application of the horizontal directional drilling is specified by the documentation of the Manufacturer.

Restrained socket joints «TYTON» and «RJ» permit to use ductile iron pipes in trenchless technologies of pipe laying and reconstruction of water supply systems and water disposal systems as well as in sewerage.

The length of the pipeline stalk should not exceed 300 meters long.

Advantages of the trenchless type methods with ductile iron pipes:

- Fast and easy assembling;
- The ability to set pipelines “cartridge” in restricted conditions or during a straight type of laying;
- Absence of the unrelieved stress that can have an influence on in the pipes after the process of laying;
- Maintain of the pipeline working characteristics.

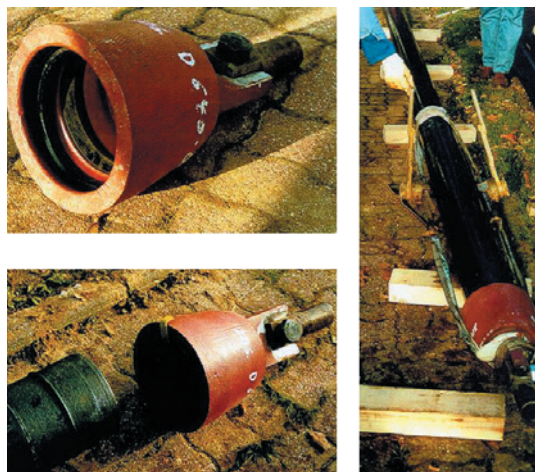

Range, types and dimensions of fittings are specified by the technical documentation of the Manufacturer.

DN, mm	Joint type	Allowable angular deflection, °	Maximum allowable tractive force, KN	Minimal radius of the pipeline curve, m
80	RJ	5	70	69
100	RJ	5	87	69
125	RJ	5	100	69
150	RJ	5	136	69
200	RJ	4	201	86
250	RJ	4	270	86
300	RJ	4	340	86
350	RJ	3	430	115
400	RJ	3	510	115
500	RJ	3	670	115
600	RJS	2	860	172
700	RJS	1,5	1000	230
800	RJS	1,5	1110	230
900	RJS	1,5	1260	230
1000	RJS	1,5	1380	230



PIPES SHIPPING SETS AND STORAGE

Pipes and fittings are furnished with stoppers (for «RJ» and «RJS» joints) and rubber gaskets designed for water supply systems, the material of the rubber gaskets is approved by the Federal Supervision Agency for Customer Protection and Human Welfare.

Number of rubber gaskets required for 1 km of pipes: 167 pieces.



Pipe Storage

1. The pipe storage area should be flat.
2. Before pipes go into stock they should be inspected and, if some damage (damage of inner or outer coating) is found it must to be fixed.
3. Pipes are stacked according to diameter and to the stock plan
4. The time the pipes are in stacks should be reduced to a minimum.
5. Crane hook for pipe handling should be covered with protection (e.g. rubber) to avoid breaking of the inner lining.
6. Wooden spacers used for stacking should be straight and of good quality.
7. Pipes can be stored on special shelves preventing rolling and damaging of pipes.
8. The stack height should not exceed 2.5 m at storage.

Rubber Gaskets Storage

The rubber gaskets should be stored under the following conditions:

1. Conditions of rubber gaskets storage should prevent any kind of their deformation. Temperature of rubber gaskets storage should be lower than 0° and not exceeding 35°C at a distance 1 meter from heaters.
2. Rubber gaskets should be protected from direct sunlight, artificial light with high UV share and substances destroying rubber. Ozone is especially harmful for rubber gaskets, so in the storage room there should be no equipment generating ozone or powerful electrical equipment which could provoke appearance of electric sparks or slow electrical discharge.
3. It is allowed to store rubber gaskets in unheated warehouses, at a temperature less than -40°C, preventing all kinds of deformation. After storage at negative temperatures, rubber gaskets should be kept minimum 24 hours at a temperature (20±5)°C before mounting.

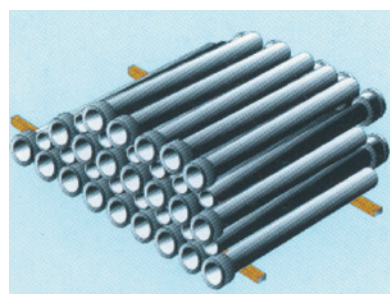
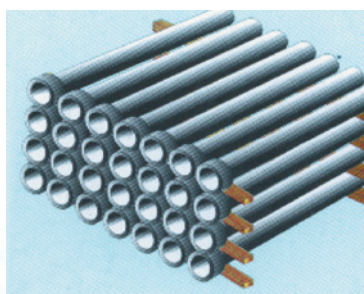
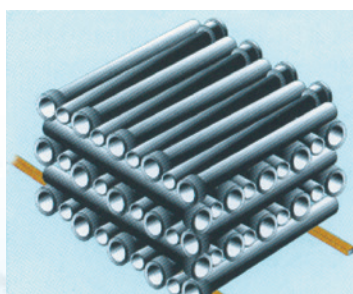

MANAGEMENT SYSTEM CERTIFICATION



**LLC "LIPETSK PIPE COMPANY
"SVOBODNY SOKOL"**
1 Zavodskaya Sq., Lipetsk
RUSSIA

Bureau Veritas Certification Holding SAS – UK Branch certifies that the Management System of the above organisation has been audited and found to be in accordance with the requirements of the management system standards detailed below

ISO 9001:2015

Scope of certification

**MANUFACTURING OF DUCTILE
IRON PIPES, FITTINGS AND SHAPED CASTINGS**

Original cycle start date: **20 May 2016**
 Expiry date of previous cycle: **N/A**
 Certification Audit date: **16 May 2016**
 Certification cycle start date: **20 May 2016**

Subject to the continued satisfactory operation of the organization's Management System, this certificate expires on: **19 May 2019**

Certificate No. **RU229011Q-U** Version: No. 2 Revision date: **02 August 2018**

 Technical manager JSC "Bureau Veritas Certification Rus"
 Skitina V.V.



008

Certification body address: 66 Prescot Street, London E1 8HG, United Kingdom
 Local office: Floors 2&3, 30, Marshala Proshyaykova St., "Zenith-Plaza", Moscow, Russia, 123458



Further clarifications regarding the scope of this certificate and the applicability of the management system requirements may be obtained by consulting the organisation.
 To check this certificate validity please call: +7 (495) 2287848

ISO 9001
«Quality Management System»



**LLC "LIPETSK PIPE COMPANY
"SVOBODNY SOKOL"**
1 Zavodskaya Sq., Lipetsk
RUSSIA

Bureau Veritas Certification Holding SAS – UK Branch certifies that the Management System of the above organisation has been audited and found to be in accordance with the requirements of the management system standards detailed below

ISO 14001:2015

Scope of certification

**MANUFACTURING OF DUCTILE
IRON PIPES, FITTINGS AND SHAPED CASTINGS**

Original cycle start date: **20 May 2016**
 Expiry date of previous cycle: **N/A**
 Certification Audit date: **16 May 2016**
 Certification cycle start date: **20 May 2016**

Subject to the continued satisfactory operation of the organization's Management System, this certificate expires on: **19 May 2019**

Certificate No. **RU229011E-U** Version: No. 2 Revision date: **02 August 2018**

 Technical manager JSC "Bureau Veritas Certification Rus"
 Skitina V.V.



008

Certification body address: 66 Prescot Street, London E1 8HG, United Kingdom
 Local office: Floors 2&3, 30, Marshala Proshyaykova St., "Zenith-Plaza", Moscow, Russia, 123458



Further clarifications regarding the scope of this certificate and the applicability of the management system requirements may be obtained by consulting the organisation.
 To check this certificate validity please call: +7 (495) 2287848

ISO 14001
«Environmental Management System»



**LLC "LIPETSK PIPE COMPANY
"SVOBODNY SOKOL"**
1 Zavodskaya Sq., Lipetsk
RUSSIA

Bureau Veritas Certification Holding SAS – UK Branch certifies that the Management System of the above organisation has been audited and found to be in accordance with the requirements of the management system standards detailed below

OHSAS 18001:2007

Scope of certification

**MANUFACTURING OF DUCTILE
IRON PIPES, FITTINGS AND SHAPED CASTINGS**

Original cycle start date: **20 May 2016**
 Expiry date of previous cycle: **N/A**
 Certification Audit date: **16 May 2016**
 Certification cycle start date: **20 May 2016**

Subject to the continued satisfactory operation of the organization's Management System, this certificate expires on: **19 May 2019**

Certificate No. **RU229011H-U** Version: No. 2 Revision date: **02 August 2018**

 Technical manager JSC "Bureau Veritas Certification Rus"
 Skitina V.V.



008

Certification body address: 66 Prescot Street, London E1 8HG, United Kingdom
 Local office: Floors 2&3, 30, Marshala Proshyaykova St., "Zenith-Plaza", Moscow, Russia, 123458



Further clarifications regarding the scope of this certificate and the applicability of the management system requirements may be obtained by consulting the organisation.
 To check this certificate validity please call: +7 (495) 2287848

OHSAS 18001
«Occupational Health And Safety
Management System»

PRODUCT CERTIFICATION



ACCREDIA
ACCREDITED TO EN ISO 9001:2015
 ACCREDITED TO EN ISO 14001:2015
 ACCREDITED TO EN ISO 45001:2018
 Member of the ACCREDITED TO EN ISO 9001:2015, ISO 14001:2015 & ISO 45001:2018
 Member of the ACCREDITED TO EN ISO 9001:2015, ISO 14001:2015 & ISO 45001:2018

ICIM

Certificazione di Prodotto Product Certification

ALLEGATO ALL'ANNEX TO
Certificato N. 008CO/2
 Certificate No.

"TYTON PUSH-ON JOINT"
 Giunti elastici antiriflusso da DN80 a DN1000, guarnizioni "Tyton"
 Push-in flexible joint DN80 to DN1000, "Tyton" seals

Classi di Pressione / Pressure classes		
Da / From DN 80 a / to DN 300	Da / From DN 350 a / to DN 600	Da / From DN 700 a / to DN 1000
C48, C58, C64, C100	C30, C48, C58	C25, C38

"TYTON SIT" PUSH-ON JOINT
 Giunti elastici antiriflusso da DN80 a DN400, guarnizioni "Tyton"
 Restrained flexible joint from DN80 to DN400, "Tyton" seals

Classi di Pressione / Pressure classes			
DN	Da / From DN 80 a / to DN 100	Da / From DN 125 a / to DN 200	Da / From DN 250 a / to DN 400
Classi di Pressione / Pressure classes	C100	C64	C38
PPA	18	16	18

Prove di tipo eseguite su DN200 e DN400 / Performance tests carried out on DN200 and DN400

"RJ" and "RJS" PUSH-ON JOINT WITH RESTRAINING SYSTEM
 Giunti elastici antiriflusso da DN80 a DN1000, guarnizioni "Tyton"
 Restrained flexible joint from DN80 to DN1000, "Tyton" seals

Joint type		"RJ" joint		"RJS" joint	
DN	Da / From DN 80 a / to DN 250	Da / From DN 300 a / to DN 500			
Classi di Pressione / Pressure classes	C48, C58, C64	C100	C30, C48	C58	
PPA	48	64	38	48	

Guarnizioni in accordo a EN 681-1 tipo W4+W6, rivestimento di zinco metallico o acciaio in zinco in accordo ad EN545 app. D.1.1, rivestimento in malta cementizia S45.2010 - ISO 4179
 Gaskets conforming to EN 681-1 type W4+W6, metallic zinc coating with finishing by zinc or steel in zinc in accordance with EN545 app. D.1.1, cement mortar in accordance with UNI EN 545.2010 - ISO 4179

ICIM S.p.A.

PRIMA EMISSIONE / FIRST ISSUE: 02/02/2011
 EMISSIONE CORRENTE / CURRENT ISSUE: 21/03/2017

ICIM S.p.A. - Piazza Don Enrico Magari, 75 - 20089 Sesto San Giovanni (MI)

ACCREDIA
ACCREDITED TO EN ISO 9001:2015
 ACCREDITED TO EN ISO 14001:2015
 ACCREDITED TO EN ISO 45001:2018
 Member of the ACCREDITED TO EN ISO 9001:2015, ISO 14001:2015 & ISO 45001:2018
 Member of the ACCREDITED TO EN ISO 9001:2015, ISO 14001:2015 & ISO 45001:2018

ICIM

Certificazione di Prodotto Product Certification

Certificato N. **ICIM-FTG-000014-00**
 Certificate No.

ALLAZIENDA / TO THE FIRM
**OOO Lipetsk Pipe Company
 "Svobodny Sokol"**
 1, Zavodskaya Sq., Lipetsk
 396007, Russia

UNITÀ OPERATIVE / OPERATIVES UNITS

PER I SEGUENTI PRODOTTI / FOR THE FOLLOWING PRODUCTS
**TUBI DI GHISA SFEROIDALE E LORO GIUNTI PER FOGNATURA
 DUCTILE IRON PIPES AND THEIR JOINTS FOR SEWERAGE APPLICATIONS**

CON DENOMINAZIONE COMMERCIALE / WITH TRADE NAMES
**"TYTON PUSH-ON JOINT"
 "TYTON SIT PUSH-ON JOINT"
 "RJ" and "RJS" PUSH-ON JOINT WITH RESTRAINING SYSTEM**

CONFORME AL DOCUMENTO NORMATIVO ICIM / IN COMPLIANCE WITH ICIM NORMATIVE DOCUMENT
ICIM 0080CS

CONFORME ALLA NORMA / IN COMPLIANCE WITH THE STANDARDS
UNI EN 598-09

Emissione / Issue: 7/2017
 Emissione Corrente / Current Issue: 12/07/2017
 Data di Scadenza / Expiry Date: 11/07/2020

ICIM S.p.A.
 Piazza Don Enrico Magari, 75 - 20089 Sesto San Giovanni (MI)

ACCREDIA
ACCREDITED TO EN ISO 9001:2015
 ACCREDITED TO EN ISO 14001:2015
 ACCREDITED TO EN ISO 45001:2018
 Member of the ACCREDITED TO EN ISO 9001:2015, ISO 14001:2015 & ISO 45001:2018
 Member of the ACCREDITED TO EN ISO 9001:2015, ISO 14001:2015 & ISO 45001:2018

ICIM

Certificazione di Prodotto Product Certification

Certificato N. **008CO/2**
 Certificate No.

ALLAZIENDA / TO THE FIRM
**OOO Lipetsk Pipe Company
 "Svobodny Sokol"**
 1, Zavodskaya Sq., Lipetsk, 396007, Russia

UNITÀ OPERATIVE / OPERATIVES UNITS

PER I SEGUENTI PRODOTTI / FOR THE FOLLOWING PRODUCTS
**TUBI, RACCORDI E ACCESSORI DI GHISA SFEROIDALE E LORO ASSEMBLAGGI
 PER CONDOTTE D'ACQUA
 DUCTILE IRON PIPES, FITTINGS, ACCESSORIES AND THEIR
 JOINTS FOR WATER PIPELINES**

CON DENOMINAZIONE COMMERCIALE / WITH TRADE NAMES
**"TYTON PUSH-ON JOINT"
 "TYTON SIT PUSH-ON JOINT"
 "RJ" and "RJS" PUSH-ON JOINT WITH RESTRAINING SYSTEM**

CONFORME AL DOCUMENTO NORMATIVO ICIM / IN COMPLIANCE WITH ICIM NORMATIVE DOCUMENT
ICIM 0080CS

CONFORME ALLA NORMA / IN COMPLIANCE WITH THE STANDARDS
UNI EN 545-10 - ISO 2531-09

Emissione / Issue: 02/02/2011
 Emissione Corrente / Current Issue: 21/03/2017
 Data di Scadenza / Expiry Date: 01/02/2020

ICIM S.p.A.
 Piazza Don Enrico Magari, 75 - 20089 Sesto San Giovanni (MI)

DVGW

DVGW-Baumusterprüfzertifikat DVGW type examination certificate

Anwendungsbereich / Field of application: Produkte der Wasserversorgung / products of water supply

Zertifikatinhaber / owner of certificate: LLC Lipetsk Pipe Company "Svobodny Sokol", pl. Zavodskaya, 1, RUS - Lipetsk

Vertreiber / distributor: LLC Lipetsk Pipe Company "Svobodny Sokol", pl. Zavodskaya, 1, RUS - Lipetsk

Produktart / product category: Guss- und Stahlrohre für Trinkwasserversorgung; Rohre aus duktilem Gusseisen (7801)

Produktbezeichnung / product description: Rohre aus duktilem Gusseisen

Modell / model: Gusseisenrohre "LLC Lipetsk Pipe Company"

Prüfberichte / test reports: Ergänzungsprüfung: 1130-700324 16-02 vom 15.11.2016 (MPG)
 Baumusterprüfung: 1130-700324 16-01 vom 06.07.2016 (MPG)
 KTW-Prüfung: K-2744137-16-S/1st vom 11.08.2016 (WHY)
 KTW-Prüfung: K-269489-16-Ko vom 12.04.2016 (WHY)
 Mikrobiologische Prüfung: W-260755e-15-S/1te vom 25.08.2015 (WHY)

Prüfgrundlagen / test basis: DVGW GW 337-P (01.09.2010)
 DIN EN 545 (01.09.2011)
 DVGW W 247 (01.04.2006)
 UBA BESCH-LL (16.03.2016)
 UBA ELASTOM (16.03.2016)
 DVGW W 270 (01.11.2007)

Ablaufdatum / AZ / date of expiry / file no.: 06.07.2021 / 16-0459-WNE

03.03.2017 CI A-12
CI A-12, Besondere Prüf- und Prüfverfahren
 date issued by: sheet, head of certification body

DVGW CERT GmbH ist von der DAKS nach DIN EN ISO/IEC 17065:2013 akkreditiert, besitzend der Zertifizierung von Produkten der Energie- und Wasserversorgung.

DVGW CERT GmbH is accredited by DAKS according to DIN EN ISO/IEC 17065:2013 for the certification of products for energy and water supply industry.

DAKS
 Deutsche
 Akkreditierungsstelle
 GbR-16103-03-03

DVGW CERT GmbH
 Zertifizierungsstelle
 Josef-Wilmer-Str. 1-3
 53123 Bonn
 Tel: +49 228 91 88-555
 Fax: +49 228 91 88-993
 www.dgwg-cert.com
 info@dgwg-cert.com

WRAS
 APPROVED MATERIAL

Water Regulations Advisory Scheme Ltd.
 Unit 13,
 Willow Road,
 Pen Y Fan Industrial Estate,
 Cwmdu,
 Gwent,
 NP11 4EG

odny Sokol

WATER REGULATIONS ADVISORY SCHEME LTD. (WRAS)
MATERIAL APPROVAL

This letter is suitable for contact with wholesome water for domestic purposes having met the WRAS and/or 2014 Suitability of non-metallic products for use in contact with water intended for human consumption on the quality of the water.

It is its effect on the quality of the water with which it may come into contact and does not signify the approval of its mechanical or physical properties for any use.

COATINGS, PAINTS & LININGS - FACTORY APPLIED PIPE & FITTINGS COATINGS. 5030

SPCML Cement Mortar. Factory applied, grey coloured cement mortar.

The cement and sand is dry mixed in a mass ratio of 1:1.2:1.5. Water is then added to the dry mix to give a cement/water mass ratio of 1:0.45:0.55. Cure for 8 hours at 60°C. For use with water up to 60°C.

This material is only approved for the mixing, application and curing conditions that appear on the approval. If the mixing, application and cure conditions are varied from those specified on the approval then the material is not covered by the scope of the approval.

APPROVAL NUMBER: 1708561
APPROVAL HOLDER: LIPETSK PIPE COMPANY "SVOBODNY SOKOL"

The Scheme reserves the right to review approval.
 Approval 1708561 is valid between August 2017 and August 2022

An entry, as above, will accordingly be included in the Water Filings Directory on-line under the section headed, "Materials which have passed full tests of effect on water quality".

The Directory may be found at: www.wrass.co.uk/directory

Yours faithfully

Jason Furnell
 Approvals & Enquiries Manager
 Water Regulations Advisory Scheme

The Water Regulations Advisory Scheme Ltd. Registered in England No. 3002030 Registered office: 4D Leach Close, Hazel Grove, Stockport, SK7 2SD
 Tel: +44(0)161 257 6200 Fax: +44(0)161 254 5940 Email: enquiries@wrass.co.uk



**SVOBODNY
SOKOL**

REPRESENTATIVES in EUROPE

SVOBODNY SOKOL POLAND is the exclusive representative of Lipetsk Pipe Company "Svobodny Sokol" in the territory of Poland.

ul. Serbska 6B/18
61-696 Poznan
+48 600 401 835
www.svsokol.pl

DIPCOM AG is an official representative of Lipetsk Pipe Company "Svobodny Sokol" in Switzerland

Turmstrasse 28
6312 Steinhausen
Switzerland
+41 41 320 37 37
www.dipcom.ch

EKO LUX d.o.o is the exclusive representative of Lipetsk Pipe Company "Svobodny Sokol" in the territory of Slovenia

Medlog 15, 3000, Celje, Slovenia.
+386 41 648 929,
+386 3 78 00 852
www.ekolux.si

GEOTRADE HANDELSGES.m.b.H. is an official representative of Lipetsk Pipe Company "Svobodny Sokol" in Austria

Hochstraß 84, A-4312 Ried in der Riedmark
+43-664-4655979
www.geotrade.at

Ingenieurburo Maurer R. - IBMR UG is the exclusive representative of Lipetsk Pipe Company "Svobodny Sokol" in the territory of Germany, Switzerland, Austria, Italy, Luxembourg and Liechtenstein.

IBMR UG
Goethestraße 20, 82110 Germering, Germany
+49 176 75727046
r.maurer@ibmr.eu

EUROPEAN PIPELINE ENGINEERING (Southern) Limited is an official representative of Lipetsk Pipe Company "Svobodny Sokol" in United Kingdom

Pegham Industrial Park, Laveys Lane
Funtley, Fareham, Hampshire, PO15 6SD
+44(0)1329 843 003,
+44(0)7850 906077,
+44 (0) 872 110 6125
www.epe.co.uk

KRISTÁLY Kft. is the official representative of Lipetsk Pipe Company "Svobodny Sokol" in the territory of Hungary

8600 Siófok, Fő u. 15-17
+36 30 641-3660
+36 30 688-4408
www.kristaly.hu

LIPETSK PIPE COMPANY «SVOBODNY SOKOL»

1, Zavodskaya Sq., Lipetsk, Russia, 398007

Export Sales Department

Tel.: +7 (4742) 42-33-20

Tel.: +7 (4742) 42-33-91

ims@me.com

export@svsokol.ru

www.ltk.svsokol.ru